

This Australian Standard was prepared by Committee MT/7, Non-destructive Testing of Metals and Materials. It was approved on behalf of the Council of the Standards Association of Australia on 4 December 1987 and published on 17 June 1988.

AUSTRALIAN STANDARD

The following interests are represented on Committee MT/7:

Australian Nuclear Science & Technology Commission  
Australian Institute for Non-destructive Testing  
Australian Pipeline Industry Association  
Australian Welding Institute  
Bureau of Steel Manufacturers of Australia  
Confederation of Australian Industry  
Department of Defence  
Department of Industrial Relations and Employment, N.S.W.  
Department of Labour and Industry, Victoria  
Electricity Supply Association of Australia  
Hawker de Havilland Victoria, Aerospace Manufacturing Sector  
Institute of Australian Foundrymen  
Metal Trades Industry Association of Australia  
National Association of Australian State Road Authorities  
National Association of Testing Authorities  
Pipeline Authority  
Railways of Australia Committee  
Society of Automotive Engineers, Australasia

*Review of Australian Standards. To keep abreast of progress in industry, Australian Standards are subject to periodic review and are kept up-to-date by the issue of amendments or new editions as necessary. It is important therefore that Standards users ensure that they are in possession of the latest edition, and any amendments thereto. Full details of all SAA publications will be found in the Catalogue of SAA Publications; this information is supplemented each month by SAA's journal 'The Australian Standard', which is sent to all members receive, and which gives details of new publications, new editions and amendments, and of withdrawn Standards. Suggestions for improvements to Australian Standards, addressed to the head office of the Association, are welcomed. Notification of any inaccuracies or ambiguity found in an Australian Standard should be made without delay in order that the matter may be investigated and appropriate action taken.*

This Standard was issued in draft form for comment as DR 86155.

# NON-DESTRUCTIVE TESTING— ULTRASONIC TESTING OF CARBON AND LOW ALLOY STEEL FORGINGS

AS 1065—1988

First published as AS 1065—1971.  
Revised and redesignated AS 1065—1978.  
Second edition 1988.

PUBLISHED BY THE STANDARDS ASSOCIATION OF AUSTRALIA  
STANDARDS HOUSE, 80 ARTHUR ST, NORTH SYDNEY, N.S.W.

ISBN 0 7262 5053 8

## PREFACE

This Standard was prepared by the Association's Committee on Non-destructive Testing of Metals and Materials by its subcommittee on ultrasonic testing, to supersede AS 1065-1978, *Methods for ultrasonic testing of ferritic steel forgings*. It sets out methods for manual ultrasonic testing of carbon and low alloy steel forgings at three recording levels by the use of equivalent reflector sizes.

The Standard covers the use of pulse-echo ultrasonic testing equipment under direct contact conditions. It describes various test methods (using ultrasonic sound waves) which may be specified by manufacturers of forgings, inspecting authorities, or purchasers of forgings for the testing of steel forgings. In this edition, levels of evaluation sensitivity based on equivalent flat bottom hole reflectivity criteria have been introduced.

## CONTENTS

	Page
FOREWORD .....	4
SECTION 1. SCOPE AND GENERAL	
1.1 SCOPE .....	5
1.2 REFERENCED DOCUMENTS .....	5
1.3 DEFINITIONS .....	5
SECTION 2. EQUIPMENT AND CALIBRATION	
2.1 GENERAL .....	5
2.2 PRESENTATION .....	5
2.3 ASSESSMENT OF HORIZONTAL AND VERTICAL LINEARITY .....	5
2.4 GAIN CONTROL .....	5
2.5 FREQUENCY RANGE .....	5
2.6 PROBES .....	5
2.7 OVERALL SYSTEM GAIN .....	5
2.8 RESOLUTION .....	5
2.9 COUPLANTS .....	5
2.10 CALIBRATION BLOCKS .....	5
2.11 REFERENCE BLOCKS .....	5
SECTION 3. METHODS OF TEST	
3.1 GENERAL .....	6
3.2 PREPARATION OF TEST SURFACES .....	6
3.3 PREPARATION FOR TESTING .....	6
3.4 ATTENUATION .....	6
3.5 PROBES .....	6
3.6 METHOD .....	6
3.7 SENSITIVITY .....	7
3.8 SCANNING REQUIREMENTS .....	7
SECTION 4. EVALUATION OF TEST DATA	
4.1 ACCEPTANCE CRITERIA .....	10
4.2 INTERPRETATION AND RECORDING OF INDICATIONS .....	10
SECTION 5. PRESENTATION OF TEST DATA	
5.1 GENERAL .....	10
5.2 RECORD OF TEST .....	10
5.3 TEST REPORT .....	10
APPENDICES	
A INFORMATION TO BE SUPPLIED WITH THE ENQUIRY OR ORDER .....	11
B FACTORS INFLUENCING PROBE SELECTION .....	13
C USES OF REFLECTIVITY (DGS) DIAGRAMS .....	14
D COMPENSATION FOR CONVEX CURVATURE .....	18
E SELECTION OF BEAM ANGLE FOR HOLLOW FORGINGS .....	20
F CLASSIFICATION OF DISCONTINUITIES .....	21
G METHODS FOR SIZING OF DISCONTINUITIES BY THE INTENSITY DROP METHOD .....	26
H METHODS FOR THE DETERMINATION OF ATTENUATION AND TRANSFER LOSSES .....	31

© Copyright — STANDARDS ASSOCIATION OF AUSTRALIA 1988

Users of Standards are reminded that copyright subsists in all SAA publications. Except where the Copyright Act otherwise allows, no part of this publication may be reproduced, stored in a retrieval system in any form or transmitted by any means without prior permission in writing of the Standards Association of Australia. Requests for permission should be directed to the Head Office of the Association. Where such requests relate to the reproduction of the whole or a substantial part of any Standard, permission may be conditional on an appropriate royalty payment.

## FOREWORD

Procedures described in this Standard make it possible to locate the discontinuities in forgings which have been machined, and which have received a grain-refining heat treatment. In addition, hot-rolled bar substituting for a forged bar can be tested by this method.

Ultrasonic testing of forgings to this Standard is carried out using normal probes. Angle or shear wave probes are used where the geometry of the forging prevents a comprehensive test, or to further evaluate indications detected by normal probes. Examination of forgings which have not been machined or which have not received a grain-refining heat treatment may be severely restricted and comparison with a calibration block cannot be applied rigidly under these conditions. Ultrasonic testing of forgings for quality assurance in either of these conditions is not recommended. Where adequate grain refining heat treatment has not been carried out and direct comparison with standard fine-grained calibration blocks is not appropriate, alternative blocks or sections of the forging itself should be used to evaluate sensitivities.

## STANDARDS ASSOCIATION OF AUSTRALIA

Australian Standard  
NON-DESTRUCTIVE TESTING—ULTRASONIC TESTING OF CARBON AND  
LOW ALLOY STEEL FORGINGS

## SECTION 1. SCOPE AND GENERAL

**1.1 SCOPE.** This Standard sets out methods for manual ultrasonic testing of carbon and low alloy steel forgings, at three recording levels, by the use of equivalent reflector sizes.

NOTE: Appendix A sets out information that should be supplied to the testing personnel before the commencement of the test.

**1.2 REFERENCED DOCUMENTS.** The documents below are referred to in this Standard.  
AS 1929 Non-destructive testing—Glossary of terms

AS 1965 The measurement of surface roughness with direct-reading stylus electronic instruments  
2083 Calibration blocks and their methods of use in ultrasonic testing  
1.3 DEFINITIONS. For the purpose of this Standard, the definitions given in AS 1929 apply.

## SECTION 2. EQUIPMENT AND CALIBRATION

**2.1 GENERAL.** The ultrasonic testing system shall be capable of displaying discontinuities likely to be present in forgings and of delineating their boundaries and contours.

**2.2 PRESENTATION.** A scan presentation shall be used. The equipment shall be calibrated in accordance with AS 2083.

NOTE: C-scan presentation may be used by agreement between contracting parties.

**2.3 ASSESSMENT OF HORIZONTAL AND VERTICAL LINEARITY.** Horizontal and vertical linearity shall be assessed for the test ranges to be used. Any deviation of horizontal linearity exceeding 2 percent over the full screen width or vertical linearity exceeding  $\pm 2$  dB between 30 percent and 100 percent graticule height shall be known and recorded. Suppression should not be used. If used, its effect on vertical and horizontal linearity shall be known and recorded.

**2.4 GAIN CONTROL.** A gain control calibrated in steps not exceeding 2 dB shall be used for measuring the ratios of ultrasonic amplitudes.

**2.5 FREQUENCY RANGE.** The equipment shall be capable of testing at a frequency within the range 1 MHz to 10 MHz.

**2.6 PROBES.** Either single or twin probes may be used. They should have a nominal frequency suitable for use in the range 1 MHz to 10 MHz. Dominant frequency may be measured in accordance with AS 2083.

Probes having a specified frequency may be used by agreement, as provided for in Appendix B.

**2.7 OVERALL SYSTEM GAIN.** The overall system gain shall be assessed in accordance with AS 2083 and shall be not less than 20 dB.

**2.8 RESOLUTION.** The equipment should be capable of readily resolving adjacent reflectors with a separation along the beam axis of 2.5 wavelengths. For carbon and low alloy steels the nominal velocity of compression waves is 5920 m/s and 3230 m/s for shear waves. The resolution requirement is therefore as given in Table 2.1.

TABLE 2.1  
RESOLUTION REQUIREMENT

Nominal frequency MHz	Compression wave probes mm	Shear wave probes mm
1	14.8	8.1
2	7.4	4.1
2.5	5.9	3.3
4	3.7	2.0
5	3.0	1.6
10	1.5	0.8

**2.9 COUPLANTS.** A couplant with good wetting characteristics and compatible with the steel under test shall be used.

NOTE: The same couplants should be used for calibration and testing.

**2.10 CALIBRATION BLOCKS.** Calibration blocks as specified in AS 2083 shall be used to calibrate the testing equipment.

**2.11 REFERENCE BLOCKS.** Reference blocks shall be used to establish sensitivity and the same couplant should be used as that for the test. Blocks containing reference reflectors at various beam path lengths may be used to establish sensitivity or sections of a forging may also be used to establish sensitivity (see Example 1, Paragraph C1.3, Appendix C).

## SECTION 3. METHODS OF TEST

**3.1 GENERAL.** The size, shape, geometry and metallurgical considerations of forgings make it difficult to completely specify scanning patterns or procedures apart from the basic cross-sections shown in Figures 3.1 to 3.6 inclusive. However, it is important that the purchaser order contains sufficient information together with suitably marked-up drawings showing critical and highly stressed regions so that appropriate scanning procedures can be agreed on (see Appendix A).

**3.2 PREPARATION OF TEST SURFACES.**

**3.2.1 General requirements.** All surfaces over which probes are to be traversed shall comply with the following requirements:

- (a) The profile of test surfaces shall permit uniform probe contact throughout the test.
- (b) Roughness of the test surfaces shall not exceed  $6.3 \mu\text{m Ra}$ .

**NOTES:**

1. A machined surface is preferred for testing.
2. Where grinding is used to prepare the test surface, care is required to prevent excessive roughness and burring and to preserve the natural profile of the forging.
3. Abrasive blasting, needle gun or flame descaling, followed by wire brushing, usually produces a satisfactory testing surface, but local grinding may be necessary to produce a surface satisfactory for adequate probe contact.
4. Where possible, taper forgings should be step machined.

Methods used to prepare test surfaces shall not be detrimental to the forging.

**3.2.2 Additional surface requirements.** Where a product Standard requires a surface finish for testing better than that specified in Clause 3.2.1, the requirements of the product Standard shall apply. (See Paragraph A1, Appendix A).

**3.3 PREPARATION FOR TESTING.**

**3.3.1 Time base calibration.** The time base shall be calibrated in accordance with AS 2083 and verified against a known thickness of the forging under test to determine if sound velocity in the material varies from that of the calibration block by more than  $\pm 2\%$ .

**3.3.2 Preparation of reference blocks.** Reference blocks shall be prepared from one of the following:

(a) Blocks of material of similar composition and heat treatment as the forging.

(b) Blocks of material having known attenuation characteristics.

(c) A non-critical section of forging.

**NOTES:**

1. Reference holes should only be drilled in forgings with the approval of the purchaser. Whether such holes are repaired or allowed to remain in the forging should be at the discretion of the purchaser.
2. Where it is necessary to use side-drilled holes in lieu of flat-bottomed holes, the relationship between the two has to be known.

Where steel similar to that being tested is not available, corrections for attenuation or contact differences shall be made in accordance with Appendix H.

**3.3.3 Distance amplitude and area amplitude curves.** Distance amplitude curves may be used in the assessment of discontinuities and shall be prepared in accordance with AS 2083 using reference blocks in accordance with Clause 3.3.2.

**3.4 ATTENUATION.**

**3.4.1 General.** Heat-treated forgings covered by this Standard would be expected to exhibit attenuation characteristics so that an effective ultrasonic inspection can be carried out. However, when a critical assessment is required the attenuation characteristics throughout the region under test or in regions as near as possible to that under test shall be determined. Assessment shall be carried out in two steps, to establish the following criteria:

- (a) To determine whether the forging can be effectively tested using the nominated probe of specified type, frequency and diameter.
- (b) To determine the attenuation/transfer loss correction factor to be applied in the calibration associated with the evaluation of discontinuities.

**3.4.2 Determination of suitability for ultrasonic testing.** The procedure to be used to determine whether a forging can be effectively tested by the ultrasonic method using the specified probe(s) is as follows:

- (a) Determine attenuation coefficient in terms of dB loss/mm transit path as detailed in Appendix H. Should the attenuation coefficient exceed  $0.01 \text{ dB/mm}$ , completion of the test should be subject to:
- (i) the operator's proving that the required sensitivity can be obtained through the full thickness of the forging; and
- (ii) agreement between the purchaser and supplier.
- (b) Determine the attenuation and transfer loss correction factor as detailed in Appendix H and apply in the calibration associated with the evaluation and scanning sensitivity settings.

**3.5 PROBES.** Probes used should be selected in accordance with the recommendations given in Appendix B, having due regard to the location, size and orientation of possible discontinuities. The beam axis should be as close as possible to normal incidence to the maximum reflecting surface(s) of any anticipated discontinuity.

**3.6 METHOD.** Forgings shall be tested using normal probes to ensure that, as far as possible, the whole volume of the forging is scanned in those regions specifically identified as critical or highly stressed. The testing shall be carried out using such different normal probes as are necessary to ensure that discontinuities at all likely locations and orientations are detected.

**NOTE:** Angle probes may be used by agreement (see Paragraph A1, Appendix A).

All testing shall be carried out at the scanning sensitivity specified in Clause 3.7.2.

**3.7 SENSITIVITY.**

**3.7.1 General.** The forging or specified areas of the forging shall be scanned at the level of sensitivity specified in Clause 3.7.3. Discontinuities so detected shall be subsequently evaluated using the relevant sensitivity specified in the product Standard or application Standard.

The relationship between the scanning sensitivities specified in Clause 3.7.2, the evaluation sensitivities specified in Clause 3.7.3, and the requirements for recording are outlined in an abridged form in Table 3.1.

**3.7.2 Scanning sensitivity.** Scanning shall be carried out using a gain at least 6 dB greater than that required to bring the signal from a 6 mm diameter flat bottom hole reference reflector at the maximum beam path length to 40% gratulate height. For long items the beam path may be divided into sections to improve clarity of presentation.

**3.7.3 Evaluation and recording sensitivity.** The sensitivity to be used for evaluation of discontinuities shall be that necessary to bring to an amplitude of 40% screen height a signal from the 6 mm diameter flat bottom hole reference reflector at the same beam path length as the discontinuity.

Discontinuities shall be evaluated and recorded for reflectivity, dimension (length, width and length, where possible), and location in accordance with Table 3.1, using one of the following levels:

- (a) *Level 1*—one-half of the above amplitude or greater.
- (b) *Level 2*—equal to the above amplitude or greater.
- (c) *Level 3*—double the above amplitude or greater.
- 3.7.4 Alternative scanning and evaluation sensitivities.** Where reference reflectors, evaluation and recording levels other than those listed above are required by the purchaser, these details should be specified at the time of enquiry or order (see Paragraph A1, Appendix A).
- Where no evaluation and recording level sensitivity is specified at the time of enquiry or order, Level 2 shall be applied.

**3.8 SCANNING REQUIREMENTS.**

**3.8.1 General.** Scanning shall be carried out from the surfaces nominated in Clauses 3.8.2 to 3.8.8 inclusive, and to the extent of coverage as listed. As far as practicable, the entire forging shall be subjected to ultrasonic examination. The scanning rate shall not exceed  $150 \text{ mm/s}$ .

Twin crystal probes should be used for close-to-surface examination.

**3.8.2 Cylindrical forgings (longitudinally forged).** Unless otherwise specified in the order or contract, solid forgings of circular cross-section shall be examined radially over the complete length through a minimum arc of  $180^\circ$  degrees and where practicable, in a longitudinal direction using a normal probe (see Figure 3.1).

**NOTE:** 360 degrees is preferred for the detection of near-surface discontinuities, and the forgings may be examined while rotating in a lathe or on rollers. If not specified by the purchaser, either method can be used at the supplier's option.

**3.8.3 Multiaxial forgings (longitudinally forged).** Unless otherwise specified in the order or contract, solid forgings of cross-sections shown in Figures 3.2 and 3.3 shall be examined over the complete length from a minimum of two-side faces at  $90^\circ$  degrees and where practicable, in a longitudinal direction, using a normal probe.

**NOTE:** Testing from all faces is preferred for the detection of near-surface discontinuities.

Where practicable, both solid and bored forgings shall also be tested in the longitudinal direction.

**NOTE:** Forgings which are to be subsequently bored should be examined in the solid state, where central discontinuities are detected it may be necessary to examine the forging after boring.

**3.8.4 Square and rectangular forgings (longitudinally forged).** Solid forgings of square or rectangular cross-section (see Figure 3.4) shall be tested from a minimum of two side-faces at  $90^\circ$  degrees and where practicable, in a longitudinal direction using a normal probe.

**NOTE:** Testing from all six faces is preferred for detection of near-surface discontinuities.

TABLE 3.1  
TEST SENSITIVITY AND RECORDING CRITERIA

Scanning sensitivity	Evaluation sensitivity		
	Level 1	Level 2	Level 3
6 mm dia. flat bottom hole to 40% screen height at maximum beam path length + at least 6 dB	6 mm dia. flat bottom hole at discontinuity distance to 40% screen height	Record any discontinuity producing an amplitude equal to or greater than 20% gratulate height	Record any discontinuity producing an amplitude equal to or greater than 80% gratulate height
String requirements	Recordable discontinuities shall be sized for reflectivity, dimension and location within the item under test. Dimension shall include height, width and length where these parameters can be determined		
Back echo attenuation	Any condition that reduces the back echo by 50% or greater shall be recorded unless it can be proved that such a reduction is due to geometric configuration		

3.8.5 **Upset forgings.** Upset forgings shall be examined from all surfaces necessary to achieve total coverage using normal probes, supplemented by angle probes as appropriate (see Paragraph A1, Appendix A).

3.8.6 **Hollow forgings.** Hollow forgings shall be examined radially over their complete length through 360 degrees and, where practicable, in a longitudinal direction using normal probes (see Figure 3.5).

Angle probes shall be used to detect longitudinal or circumferential discontinuities which have a radial orientation, in particular those which occur adjacent to the bore surface (see Figure E1, Appendix E, for optimum probe angle).

3.8.7 **Tapered forgings.** Tapered forgings which cannot be step-machined need special consideration because some loss of back echo will occur during testing, and for this reason, interpretation of results is negotiable (see Paragraph A1, Appendix A).

3.8.8 **Complex forgings.** As complex forgings are generally, composite forms, the method used for scanning is negotiable (see Paragraph A1, Appendix A) and may consist of a combination of the above.

3.8.9 **Bored forgings.** Forgings which are to be subsequently bored should be examined where practicable in the unbored condition; where central discontinuities are detected, it may also be necessary to examine the forgings after boring (see Figure 3.6).

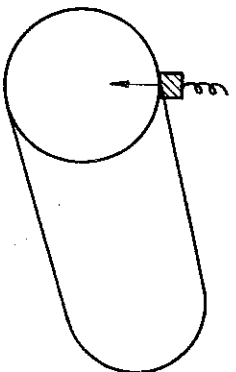

FIGURE 3.1. CIRCULAR (SOLID) CROSS-SECTION

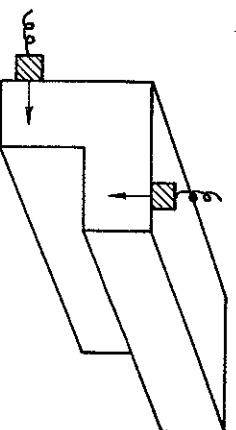

FIGURE 3.2. CORNER (FLANGE) CROSS-SECTION

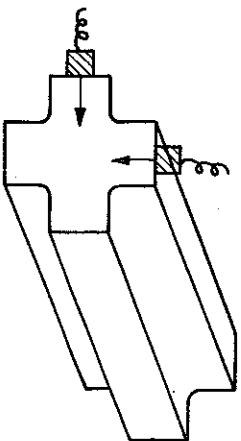

FIGURE 3.3. CRUCIFORM OR COLLARED CROSS-SECTION

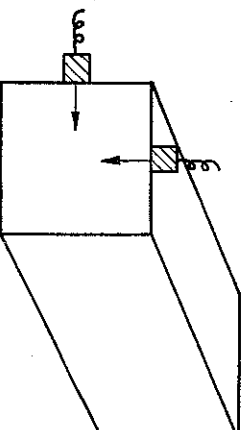

FIGURE 3.4. SQUARE OR RECTANGULAR (SOLID) CROSS-SECTION

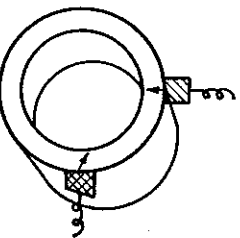

FIGURE 3.5. CIRCULAR (HOLLOW) CROSS-SECTION

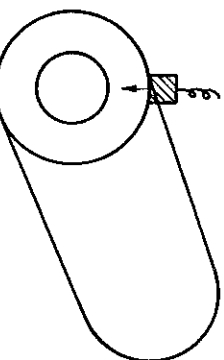

FIGURE 3.6. CIRCULAR (BORED) CROSS-SECTION

## SECTION 4. EVALUATION OF TEST DATA

**4.1 ACCEPTANCE CRITERIA.** The acceptance level for discontinuities detected by ultrasonic testing shall be as specified in the relevant product Standard, application Standard, or purchase order.

**4.2 INTERPRETATION AND RECORDING OF INDICATIONS.** The location, extent and size of discontinuities shall be assessed and recorded according to the agreed level of evaluation sensitivity given in Clause 3.7.3.

Any condition that reduces the back echo by 50% or greater shall be recorded unless it can be proved that such a reduction is due to geometric configuration.

Discontinuity indications shall be classified in accordance with the following types (see also Appendix F):

- (a) Planar.
- (b) Inclined planar.
- (c) Stringer.
- (d) Cluster.
- (e) Point.

Methods for estimating the size of a discontinuity, using the agreed sensitivity, are given in Appendices C and G and the compensation to be made for amplitude due to convex curvature is given in Appendix D.

## SECTION 5. PRESENTATION OF TEST DATA

**5.1 GENERAL.** The information given in Clause 5.2 is 'in-house' information, and is recorded so that further testing can be duplicated. The information given in Clause 5.3 is that which is sent to the purchaser, giving the result of the test.

**5.2 RECORD OF TEST.** The record of test shall include at least the following information:

- (a) Name of laboratory or testing authority.
- (b) Identification of the component.
- (c) Product Standard.
- (d) Material specification.
- (e) Number of this Australian Standard, i.e. AS 1065, the specific technique selected and any departures from the method.

NOTE: Method of establishing evaluation sensitivity should be recorded.

- (f) Areas tested (direction and extent of scanning).
- (g) Surface condition to include type of preparation and whether it complies with 6.3  $\mu\text{m } R_a$ .
- (h) Equipment and all accessories including compliant.
- (i) Presentation of test data, and whether or not it complies with the product Standard.
- (j) Any other information the purchaser requires for assessment of test results.

(l) Date and place of test.

(m) Report number and date of issue.

(n) Identification of testing personnel.

**5.3 TEST REPORT.** The test report shall include at least the following information:

- (a) Name of laboratory or testing authority.
- (b) Identification of the component.
- (c) Product Standard.
- (d) Material specification.
- (e) Surface condition.
- (f) Number of this Australian Standard, i.e. AS 1065, the specific technique selected and any departures from the method.
- (g) Area tested (direction and extent of scanning).
- (h) Surface condition to include type of preparation and whether it complies with 6.3  $\mu\text{m } R_a$ .
- (i) Presentation of test data, and whether or not it complies with the product Standard.
- (j) Any other information the purchaser requires for assessment of test results.
- (k) Date and place of test.
- (l) Report number and date of issue.
- (m) Identification of officer responsible for test report.

APPENDIX A  
INFORMATION TO BE SUPPLIED WITH THE ENQUIRY  
OR ORDER

(This Appendix does not form an integral part of this Standard)

**A1 GENERAL.** The following list details the minimum relevant information which should be supplied to the testing personnel before the commencement of the test:

- (a) Job reference number.
- (b) Product description and identification (see Paragraph A3).
- (c) Reference number of any relevant product Standard.
- (d) Manufacturing history and intended use, if applicable (see Paragraph A4).
- (e) Surface requirements (see Clause 3.2).
- (f) Whether angle probes are required to be used (see Paragraph A5).
- (g) Required method of scanning (see Clause 3.8).
- (h) Any alternative sensitivity (see Clause 3.7.4 and Paragraph A6).
- (i) Acceptance level for discontinuities, if not specified in the product Standard (see Paragraph A7).
- (j) Any agreed departures from the methods specified in this Standard (see Paragraph A8).
- (k) Whether a test report is required (see Clause 7.2 and Paragraph A9).
- (l) Reference to this Australian Standard, i.e. AS 1065.

**A2 TESTING AUTHORITIES.** The effectiveness of ultrasonic testing depends on the technical competence of the personnel performing the tests and on their ability to interpret indications. However, the responsibility of assessing the significance of discontinuities does not lie with the testing authority.

The Australian Institute for Non-destructive Testing (AINDT) operates a qualification scheme with respect to a person's general knowledge of a non-destructive testing method. These AINDT qualifications are recognized by the National Association of Testing Authorities, Australia (NATA), which operates an accreditation scheme for non-destructive testing services.

**A3 PRODUCT DESCRIPTION AND IDENTIFICATION.** All forgings should be adequately identified. They should also be accompanied by a detailed drawing showing the material specification, configuration, dimensions and particularly areas of high stress. In many instances where the forgings have a complex profile, prior consultation with testing personnel may be necessary to arrive at the best testing procedure.

**A4 MANUFACTURING HISTORY.** Where forgings are not tested at the site of manufacture, testing personnel may not be aware of treatments previously given to the forgings. It is therefore important that all relevant information be made available to testing personnel in order to avoid errors in assessment. These errors may arise from either production methods (welding, grinding etc, which can markedly influence the metallurgical properties, e.g. size, location, severity and of orientation of inherent inhomogeneities), or from subsequent fabrication (e.g. welding on of attachments which can modify the metallurgical properties of the forging).

Among the more important factors which should be known are casting details, ingot size, treatment following casting, forging reduction, forging sequences, and any relevant heat treatment.

**A5 ANGLE PROBES.** Angle probes are used to scan areas of the forging where geometry of the forging or the orientation of a suspected defect prevents examination using normal probes, and also to assist in the evaluation of any discontinuity indications detected when using normal probes.

When scanning with angle probes, the frequency, calibration, sensitivity and probe manipulation should be those used for normal probes. The selection of beam angle is made giving due consideration to the geometry of the forging, particularly of hollow forgings, where it is desirable to examine the material adjacent to the inside diameter. The optimum beam angle for any outside diameter/wall thickness ratio is given in Appendix E.

**A6 SENSITIVITY REQUIRED.** It is essential that the reference sensitivity for the test should be specified so that the results of the test may be related to a known sensitivity datum, and so that the condition of the test may be accurately reproduced, in any later retest.

Some application Standards specify the sensitivity levels to be used for particular ultrasonic tests. If this information is not available the sensitivity should be such that the smallest defect which is required to be evaluated will be clearly displayed.

**A7 DEFECT ACCEPTANCE LEVEL.** The defect acceptance level may be specified in the appropriate application Standard or product Standard. In the absence of such Standards, the defect acceptance levels are to be specified.

**A8 DEPARTURE FROM THE METHODS SPECIFIED.** If there is any need to seek a departure from the methods specified in this Standard such a departure should be clearly specified in the purchaser order. Departures from the standard methods should be written as a separate specification following consultation with the testing authority.

**A9 TEST REPORT AND RETEST.** When a test report is required this should be specified on the purchase order. Where rectification is permitted by the purchaser such details should be clearly specified together with assessment criteria for re-examination of the forging after rectification.

## APPENDIX B FACTORS INFLUENCING PROBE SELECTION

(This Appendix does not form an integral part of this Standard)

**B1 GENERAL.** The choice of probes for the examination of any forging is usually a compromise between the optimum and an economically practical method. Examination of any forging should be conducted in such a manner as to ensure that the best possible ultrasonic detection and resolution is obtained by using the highest possible frequency consistent with adequate acoustic penetration and an acceptable grass (interference) level.

Determination of the best possible compromise should be made with regard to the following features of the forging:

- (a) Geometrical shape and surface condition of the forging.
- (b) Size.
- (c) Metallurgical structure.
- (d) Probable nature, position, and orientation of possible discontinuities.
- (e) Access to areas of possible discontinuities and the availability of suitable scanning surface.

Guidance on the selection of probes is given below.

### **B2 PROBE CHARACTERISTICS.**

**B2.1 Frequency.** In most applications of ultrasonic testing of forgings the test frequency will be within the range 2 MHz to 5 MHz. However, 1 MHz to 2 MHz may be used for coarse-grained materials and 5 MHz to 10 MHz where improved resolution and sensitivity are required. Other frequencies may be used where specified. The following factors will influence the choice of frequency:

- (a) *Nature of the metal through which the beam will pass.* In coarse-grained steel, higher frequencies will be attenuated to a greater extent than lower frequencies; e.g. in coarse-grained steel where 1 MHz is required to give satisfactory penetration, 4 MHz would give unsatisfactory results because of greater attenuation and therefore less penetration.
- (b) *Size of discontinuity to be detected.* In general, the size of the discontinuity which may be detected is proportional to the wavelength of the ultrasonic beam. The higher the frequency the shorter the wavelength and the smaller the discontinuity which may be detected. It also follows that better resolution is possible at higher frequencies.
- (c) *Beam path length.* Where long beam path lengths are to be used it may be advantageous to use a lower frequency because of less attenuation.

**B2.2 Beam angle.** The objective in the selection of the beam angle should be to produce the axis of the ultrasonic beam normal to the maximum reflecting surface or surfaces of any discontinuity.

**B2.3 Probe types.** Single crystal probes are most generally used for the ultrasonic examination of forgings except when examining areas adjacent to the scanning surface, in which case twin crystal probes or short-pulse single crystal probes can be used.

APPENDIX C  
 USES OF REFLECTIVITY (DGS) DIAGRAMS  
 (This Appendix forms an integral part of this Standard)

C1 GUIDANCE ON THE USE OF THE REFLECTIVITY DIAGRAM FOR NORMAL PROBES.

C1.1 General. The reflectivity diagram for normal probes (see Figure C1) is drawn as a plot of the relative amplitude for a series of disc-shaped reflectors normal to the axis of the ultrasonic beam against the probe-to-discontinuity distance in near zone lengths.

The diagram is valid for disc-shaped discontinuities which are smaller than the beam diameter and are oriented normal to the axis of the ultrasonic beam. A correction for attenuation in the material under test should be made as described in Paragraph H4, Appendix H.

C1.2 Relative amplitude. The relative amplitude is the gain, in decibels, required to raise the amplitude of an indication to that of a known reflector. The most commonly used reflector would be the back echo or a similar boundary echo, the surface of which is normal to the axis of the beam.

C1.3 Relative size of discontinuity. The relative size  $S$ , of a discontinuity is the diameter of the discontinuity expressed as a ratio of the probe crystal diameter, as follows:

$$S = \frac{d_i}{d_c}$$

where

$d_i$  = diameter of an equivalent disc-shaped discontinuity, in millimetres

$d_c$  = diameter of probe crystal, in millimetres.

C1.4 Reflector distance. The distance,  $D$ , of the reflector (discontinuity or reflector) from the probe is given in near-zone lengths, as follows:

$$D = \frac{N_i}{N_c}$$

where

$N_i$  = distance from probe to reflector, in millimetres

$N_c$  = near-zone length for the particular probe used, in millimetres.

Although the reflectivity diagram shows  $D$  in the range of 0.1 to 1.0 (i.e. the reflector distance is less than the near-zone length) in practice it is not desirable to use this portion of the diagram because relative amplitudes in the near zone are not reliable. Similarly the diagram includes  $S$  as greater than 1.0 (i.e. the reflector diameter is greater than the crystal size) but this portion of the diagram is not generally used.

C1.5 Examples of the use of reflectivity diagrams. The following examples illustrate the use of the reflectivity diagram to establish test sensitivity and equivalent reflector size:

Example 1. Establishment of test sensitivity (gain setting).

A steel forging of 150 mm thickness is to be examined with a 2 MHz normal probe with a crystal diameter of 20 mm. The minimum detectable discontinuity is to be equivalent to a 3 mm diameter reflector.

NOTE: Attenuation was not taken into consideration.

Determine the gain setting required to display this 3 mm diameter disc-shaped indication to the required reference level at the maximum range of 150 mm when the back echo at the required reference level gives a gain setting of 12 dB. In the example assume a reference level of 100 percent graticule height.

$$N_c = \frac{4 \times (\text{Probe diameter})^2}{4 \times 2.9} = \frac{20 \times 20}{4 \times 2.9} = 34 \text{ mm}$$

$$D = \frac{N_i}{N_c} = \frac{150}{34} = 4.4$$

$$S = \frac{d_i}{d_c} = \frac{3}{20} = 0.15$$

COPYRIGHT

where

$N_c$  = near-zone length, in millimetres

$N_i$  = distance from probe to reflector, in millimetres

$d_i$  = diameter of equivalent disc-shaped discontinuity, in millimetres

$d_c$  = diameter of probe crystal, in millimetres.

From the reflectivity diagram the intersection of  $D$  (at 4.4) and  $S$  (at 0.15) gives a total amplification of 40 dB. Since at  $D$  (4.4) the back echo is 9 dB there is a 31 dB difference in amplification between the back echo and the 3 mm disc-shaped reflector. Therefore the gain setting to display the full screen height indication from the 3 mm reflector is 12 dB + 31 dB = 43 dB.

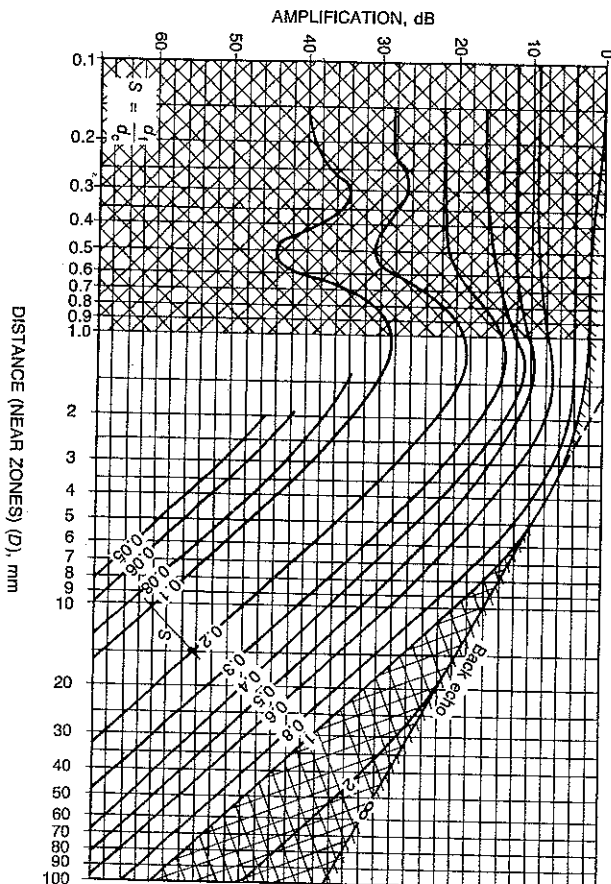

FIGURE C1. REFLECTIVITY DIAGRAM FOR NORMAL PROBES

Example 2. Determination of equivalent reflector size using a flat bottom hole.

The reflectivity diagram may be used to compare the reflectivity of a reflector of unknown size, at various beam paths, with that of a reflector of known size as follows: Obtain the reference level by adjusting the echo from a 4 mm diameter flat bottom hole at 120 mm beam path, using a 10 mm diameter, 4 MHz single crystal normal

COPYRIGHT



probe, to a convenient graticule height. A discontinuity is detected, the amplitude of which is 4 dB below the reference level at 80 mm beam path. The estimated equivalent reflector size of the discontinuity is required.

$$\text{Since } D = \frac{M_r \text{ (reference)}}{N_r} = \frac{120}{16.5} = 7.3$$

$$\text{and } S = \frac{d_r \text{ (reference)}}{d_e} = \frac{10}{4} = 0.4$$

then from the reference diagram Figure C1 the relative amplitude of the 4 mm flat bottom hole will be 18 dB greater than the back echo line.

Since the relative amplitude of the discontinuity is 22 dB (i.e. 4 dB + 18 dB) greater than the back echo line, and since—

$$D = \frac{M_r \text{ (discontinuity)}}{N_r} = \frac{80}{16.5} = 4.8$$

Then  $S = \frac{d_r \text{ (discontinuity)}}{d_e} = 0.25$

Hence for a crystal diameter of 10 mm the estimated equivalent reflector diameter will be 2.5 mm.

**Example 3. Determination of discontinuity size using back echo as the reference.**  
A steel forging 480 mm thick is to be examined using a 24 mm diameter, 2 MHz normal probe. A discontinuity indication is observed at a depth of 90 mm from the surface.

Determine the equivalent reflector size of the discontinuity indication noted.

The procedure in this case is to raise the back echo height to a convenient graticule height and note the decibel reading, say 16 dB. The discontinuity indication is then raised to the same graticule height and the new decibel reading is noted, say 34 dB. The difference between gain levels is therefore 34 dB - 16 dB = 18 dB.

Since the 480 mm thickness is equivalent to 480/48 = 10 near-zone lengths, the discontinuity indication is equivalent to 96/48 = 2 near-zone lengths.

From Figure C1 two vertical lines are drawn at these positions. At the 10 near-zone length count down 18 dB and project a horizontal line to the 2 near-zone length line. The intersection of these two lines is on the S = 0.1 curve.

Since the crystal diameter is 24 mm the equivalent reflector size is 24 x 0.1 = 2.4 mm.

**C2 GUIDANCE ON THE USE OF THE REFLECTIVITY DIAGRAM FOR ANGLE PROBES.** The reflectivity diagram for angle probes is expressed in terms of the distance in millimetres to a reflector, the gain, and the equivalent flat bottom hole reflectivity. The reflectivity diagram is therefore dependent on the probe frequency and crystal size. A reflectivity diagram for a 2 MHz, 20 mm by 22 mm crystal, angle probe is shown in Figure C2.

The application of the reflectivity diagram to angle probes differs from that for normal probes because a back echo is not generally available in the object under test. The back echo which is used as a reference is therefore obtained from a calibration or reference block, usually the 100 mm radius on a No 1 calibration block. Since the calibration block may have attenuation characteristics and a surface condition different from the object under test, the difference in attenuation and transfer losses has to be determined and applied to any gain setting derived from the reflectivity diagram. A method of determining such losses is described in Paragraph H3 of Appendix H.

**Example. Procedure for using Figure C2 to determine gain setting.**

A steel forging is to be examined with a 2 MHz angle probe with a 20 mm by 22 mm crystal size. A minimum detectable discontinuity equivalent to the reflectance of a 3 mm flat bottom hole is to be detected at 130 mm maximum range. What gain setting is required to display this reference echo at full screen height if the attenuation and transfer loss between the material under test and the No 1 calibration block is 6 dB? From the No 1 calibration block the 100 mm radius produces a full screen height echo with 12 dB of gain. Using Figure C2 the total amplification of the 100 mm radius back echo in the calibration block at 130 mm range is 3 dB and the total amplification of a 3 mm flat bottom hole at 130 mm is 29 dB. The actual amplification difference between the back echo and the 3 mm flat bottom hole is therefore 26 dB. The actual amplification difference between the back echo and the 3 mm flat bottom hole is

therefore 26 dB. Since the gain setting to achieve a full screen height echo from the 100 mm radius is 12 dB, the gain setting to raise the 3 mm flat bottom hole to full screen height is—  
12 dB + 26 dB = 38 dB

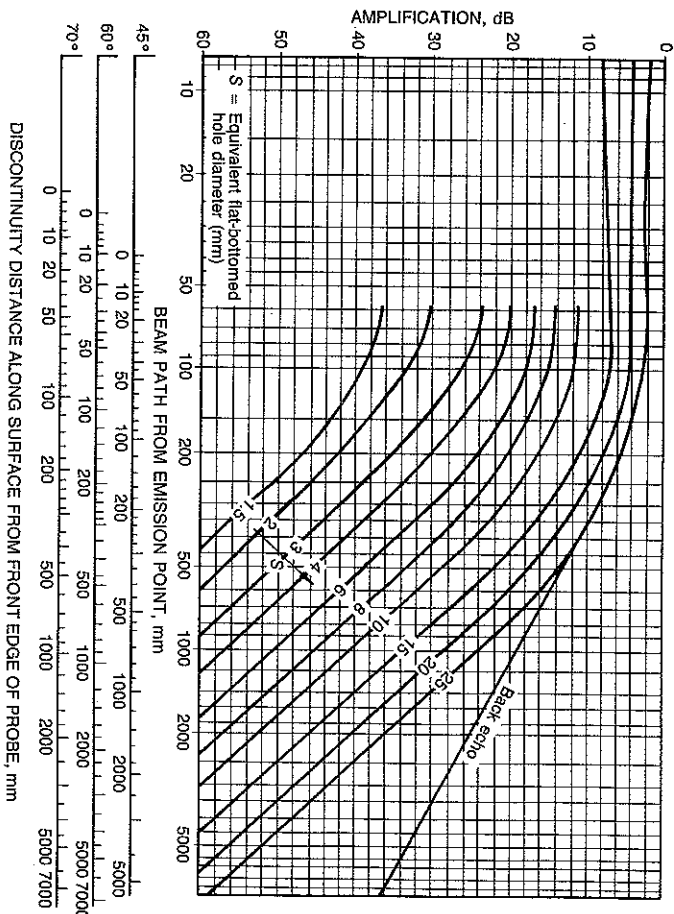

FIGURE C2. TYPICAL REFLECTIVITY DIAGRAM FOR ANGLE PROBE OF 2 MHz 20 mm x 22 mm CRYSTAL SIZE

APPENDIX D  
 COMPENSATION FOR CONVEX CURVATURE  
 (This Appendix forms an integral part of this Standard)

**D1 COMPENSATION FOR CONVEX CURVATURE OF SCANNING SURFACE.** When a flat probe is coupled to a convex shaped test surface the working sensitivity is less than that obtained when a flat probe is coupled to a flat surface, the reduction being a function of the crystal diameter and the radius of curvature of the test surface.

This compensation (i.e. increase in gain) for various probe diameters and radii of curvature may be determined by the use of the nomogram (see Figure D1) as follows:

- (a) Locate radius of curvature of test surface on left-hand scale.
- (b) Locate probe diameter on centre scale.
- (c) Rule a line joining these points and extend to intersect right-hand scale.
- (d) The points of intersection on the right-hand scale are the correction in decibels to be added.

*Example:* When a probe having a diameter of 15 mm is used on a test surface having a radius of 150 mm, the correction required is 7.7 dB, i.e. nominally + 8 dB.

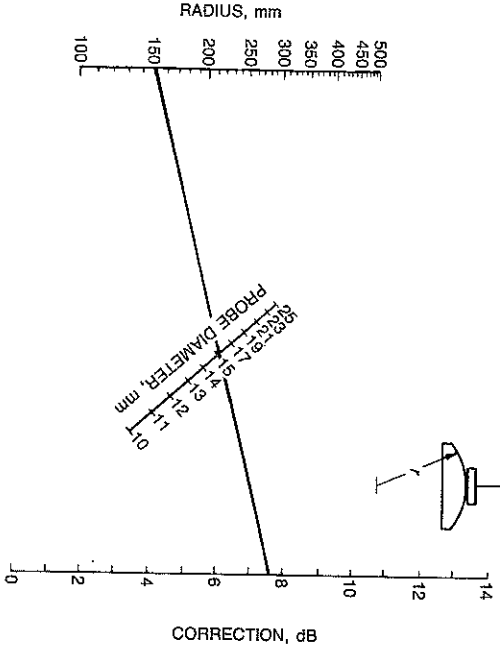

FIGURE D1. COMPENSATION FOR CURVATURE

**D2 COMPENSATION FOR CONVEX CURVATURE OF BACK WALL.** When reflectivity comparison diagrams or angle probes at greater than half-skip are used, an allowance should be made for the convex curvature of the back wall when the back echo is used as a reference to set the test sensitivity. Compensation for curvature may be obtained from the graph shown in Figure D2.

COPYRIGHT

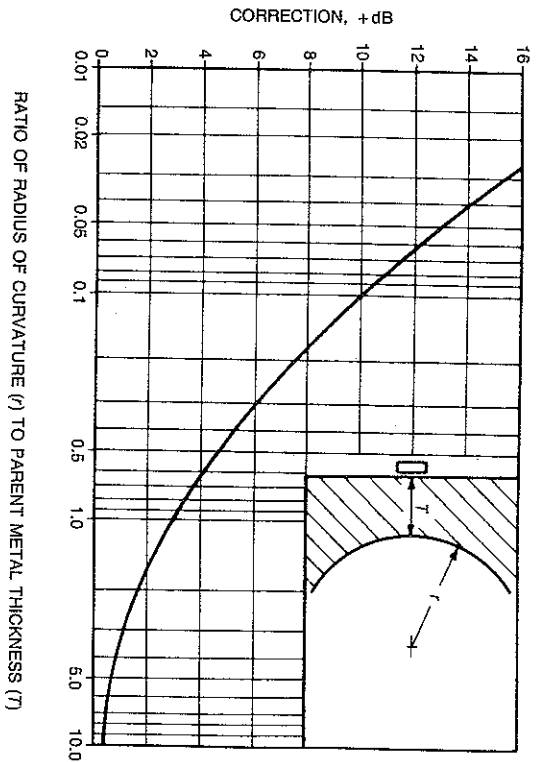

FIGURE D2. CORRECTIONS FOR VARIOUS VALUES OF  $r/T$

COPYRIGHT

APPENDIX E  
 SELECTION OF BEAM ANGLE FOR HOLLOW FORGINGS  
 (This Appendix does not form an integral part of this Standard)

When a shear wave probe is used to scan the annulus in the circumferential examination of a cylindrical hollow forging, a beam angle should be used which will give the most favourable beam to inside diameter surface alignment, i.e. the beam will graze the inside surface.

The optimum beam angle for any wall thickness/outside diameter ratio may be selected from the graph shown in Figure E1.

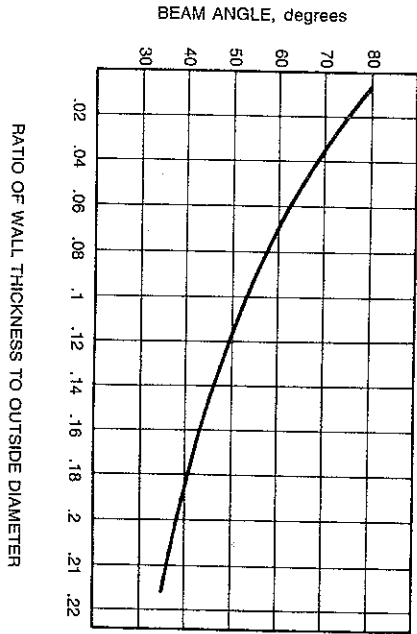

FIGURE E1. OPTIMUM BEAM ANGLE

COPYRIGHT

APPENDIX F  
 CLASSIFICATION OF DISCONTINUITIES  
 (This Appendix does not form an integral part of this Standard)

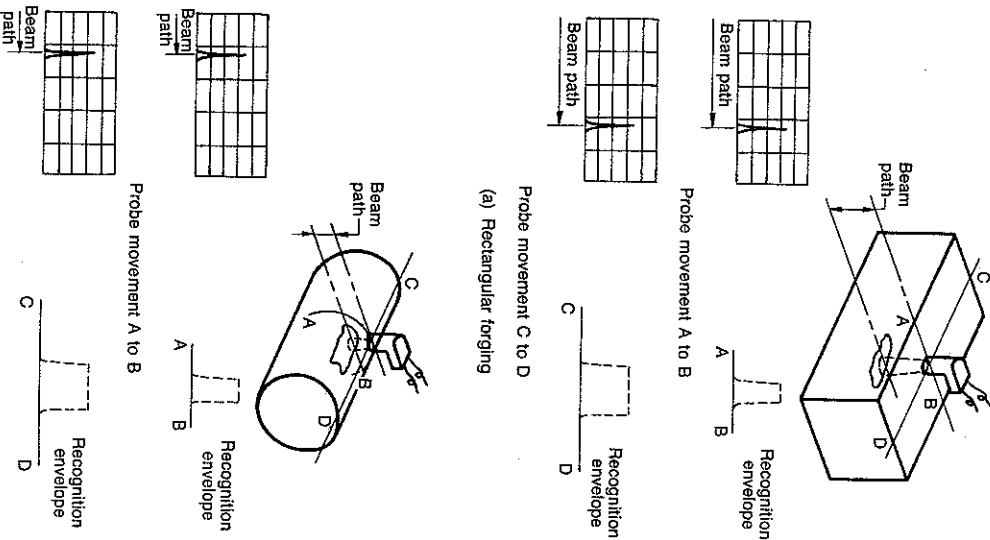

FIGURE F1. PLANAR DISCONTINUITY

COPYRIGHT

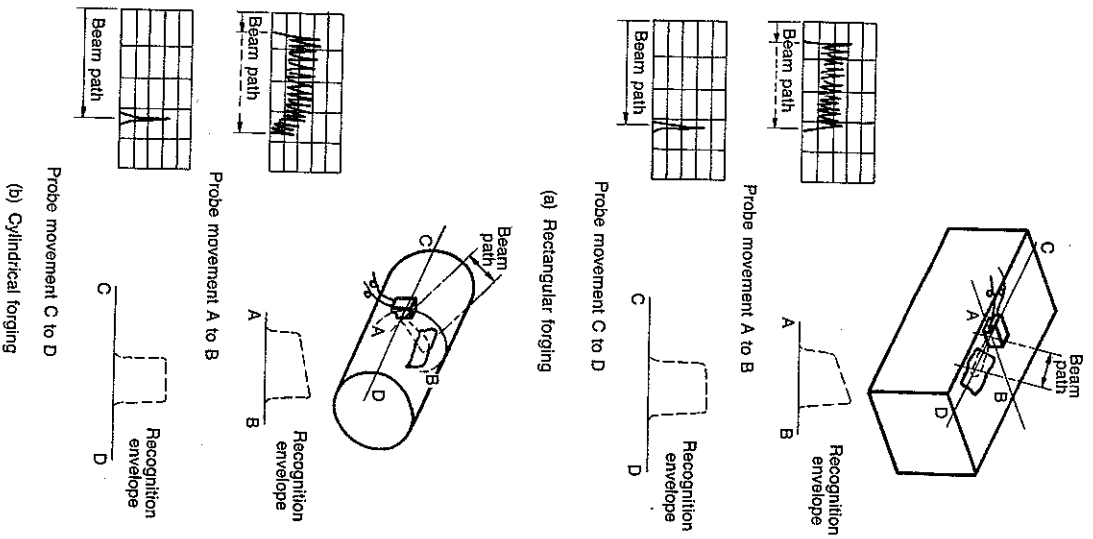

FIGURE F2. INCLINED PLANAR DISCONTINUITY

COPYRIGHT

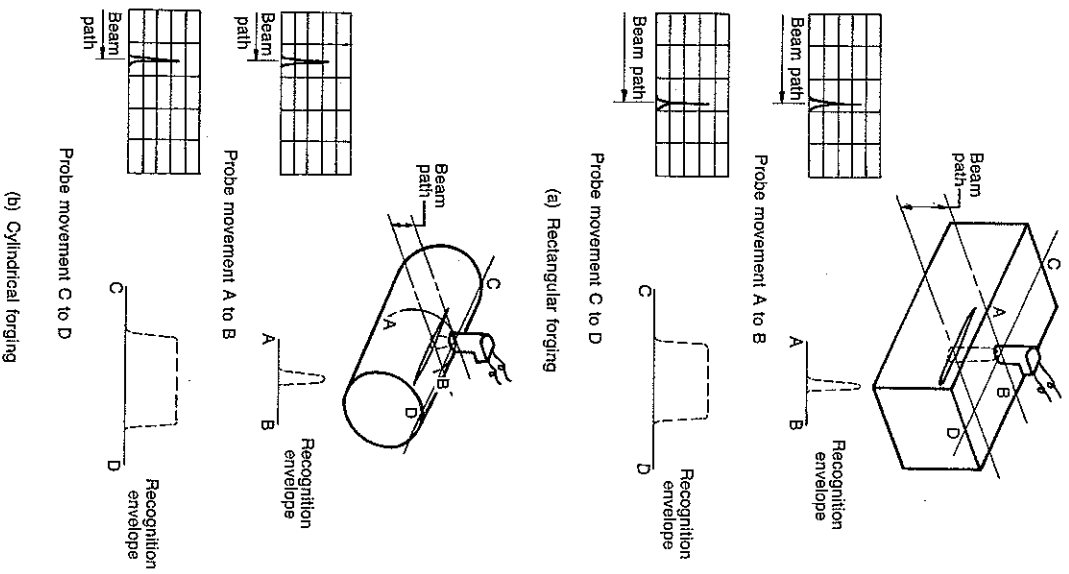

FIGURE F3. STRINGER DISCONTINUITY

COPYRIGHT

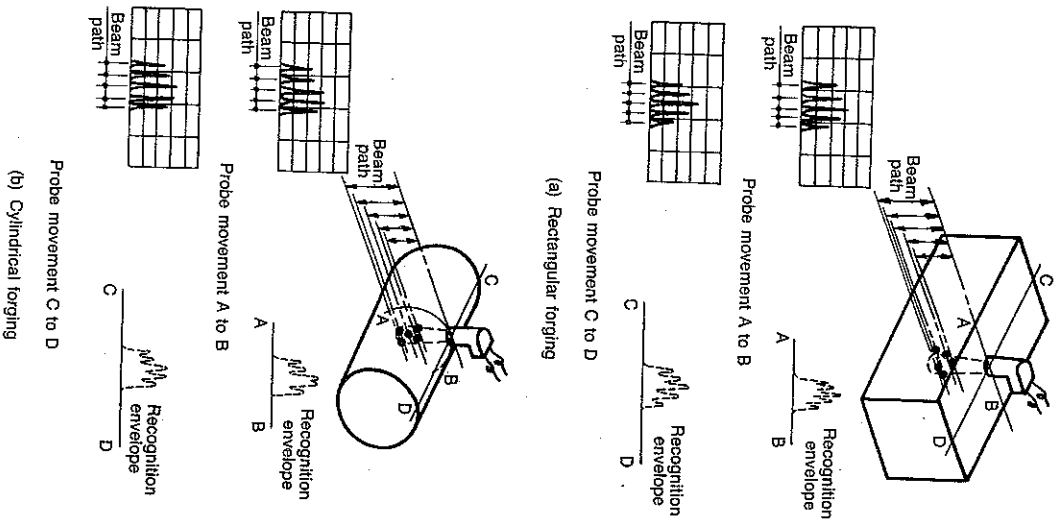

FIGURE F4. CLUSTER DISCONTINUITY

COPYRIGHT

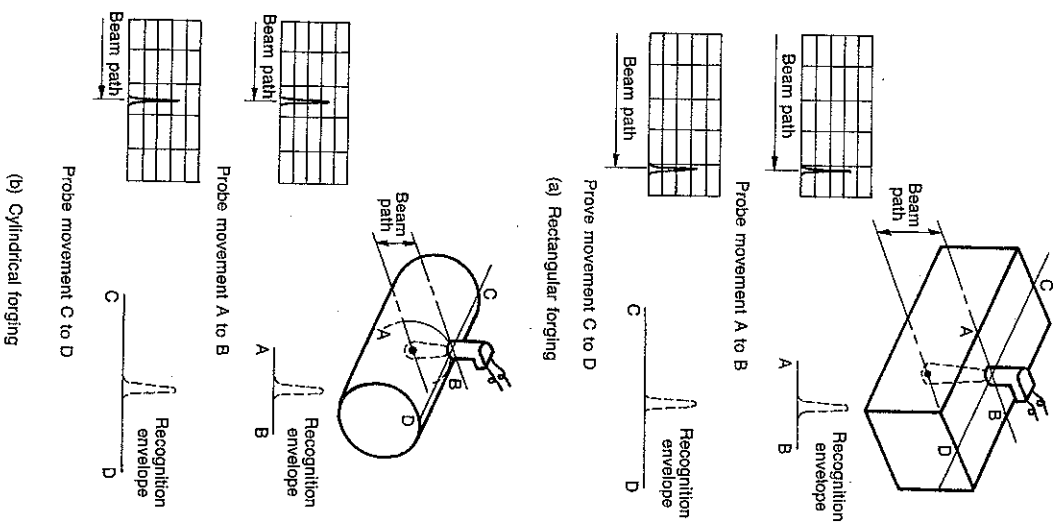

FIGURE F5. POINT DISCONTINUITY

COPYRIGHT

## APPENDIX G

### METHODS FOR SIZING OF DISCONTINUITIES BY THE INTENSITY DROP METHOD

(This Appendix forms an integral part of this Standard)

**G1 SCOPE.** This Appendix sets out methods for sizing of discontinuities in carbon and low alloy steel forgings by the intensity drop method.

**G2 PRINCIPLE.** The effective beam profile is determined by the method detailed in AS 2063 using a selected decibel drop, generally 20 dB or 6 dB. Sizing is then carried out as described in Paragraphs G3 and G4 which detail procedures for the 20 dB method.

The 6 dB drop method can be used by plotting the 6 dB beam geometry and utilizing the methods described below but with 6 dB.

**G3 METHOD FOR NORMAL PROBES USING 20 DB DROP** (see Figure G1). The procedure shall be as follows:

- (a) Move the probe over a discontinuity until the point of maximum intensity of the last significant echo is obtained (Figure G1(a)).
- The last significant echo is the point just before the signal falls off rapidly. The gain control may need adjustment to establish this point.
- (b) At this point adjust the echo height to between 80% and 100% full screen height (Figure G1(b)).
- (c) Decrease gain by 20 dB, note echo height (Figure G1(d)) and return to original setting.
- (d) Move the probe forward until the echo falls to the base line. Reverse the probe movement until echo height returns to the height obtained in Step (c) (Figure G1(c) and (d)).
- (e) Mark probe position and beam path length of echo (Figure G1(e)).
- (f) Move probe backwards repeating Steps (a) to (e).
- (g) Repeat Steps (a) to (f) at right angles.
- NOTE: On large discontinuities several more directions will be required.
- (h) Measure the probe movement ( $M$ ) and obtain the discontinuity dimension ( $L$ ) by subtracting the beam widths ( $a_1$  and  $a_2$ ) at the discontinuity beam path length (Figure G1(e)), i.e. —

$$L = M - (a_1 + a_2).$$

NOTE: Check the 20 dB drop at the actual beam path being worked at.

#### G4 METHODS FOR ANGLE PROBES USING 20 DB DROP.

**G4.1 Procedure for vertical plane** (see Figure G2). The procedure shall be as follows:

- (a) Move the probe over a discontinuity (Figure G2(a)) until the point of maximum intensity of the last significant echo is obtained (Figure G2(d)).
- The last significant echo is the point just before the signal falls off rapidly (Figure G2(e)) and is not the point of maximum response from the discontinuity (Figure G2(a) and (b)). The gain control may need adjustment to establish this point.
- (b) At this point, adjust the echo height to between 80% and 100% full screen height.
- (c) Decrease gain by 20 dB, note echo height and return to original setting.
- (d) Move the probe forward until the echo falls to the base line. Reverse the probe movement until the echo height returns to the height obtained in Step (c) (Figure G2(e) and (f)).
- (e) Mark probe position and beam path length of echo (Figure G2(g)).
- (f) Move probe backwards, repeating Steps (a) to (e).
- (g) Plot probe position and beam boundary at each position from Steps (e) and (f). Measure the range along the 20 dB boundary on the beam profile. The resultant plots should indicate the dimension and orientation of the discontinuity (Figure G2(g)).

- (h) Repeat Steps (a) to (g) from a minimum of two other surfaces for more accurate results.

NOTES:

1. This method of sizing discontinuities can tolerate minor errors in measuring the probe position and assessment of the 20 dB drop-off point.
2. The beam spread should be plotted very carefully and proved to ensure accuracy.

**G4.2 Procedure for horizontal plane** (see Figure G3). The procedure shall be as follows:

- (a) Move the probe parallel to a discontinuity until the point of maximum intensity of the last significant echo is obtained. The last significant echo is the point just before the signal falls off rapidly. The gain control may need adjustment to establish this point.
  - (b) At this point adjust the echo height to between 80% and 100% full screen height.
  - (c) Decrease gain by 20 dB, note echo height and return to original setting.
  - (d) Move the probe parallel until the echo falls to the base line. Reverse the probe movement until echo height returns to the height obtained in Step (c).
  - (e) Mark the probe position through its centreline.
  - (f) Move the probe to the opposite end of the discontinuity and repeat Steps (a) to (e).
  - (g) Measure the probe movement ( $M$ ) and obtain the discontinuity dimension ( $L$ ) by subtracting the beam widths ( $a_1$  and  $a_2$ ) at the discontinuity beam path length (Figure G3), i.e. —
- $$L = M - (a_1 + a_2)$$
- NOTES:
1. Check 20 dB drop at the actual beam path length being worked at.
  2. This method of sizing discontinuities can tolerate minor errors of measuring the probe position and assessment of the 20 dB drop-off point.
  3. The beam spread should be plotted very carefully and proved to ensure accuracy.

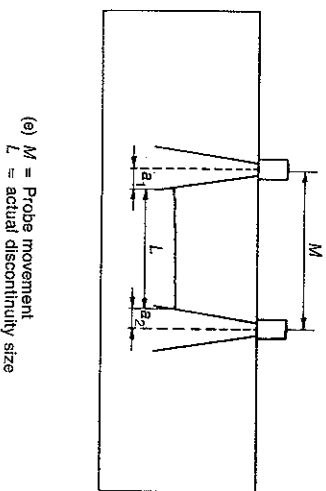
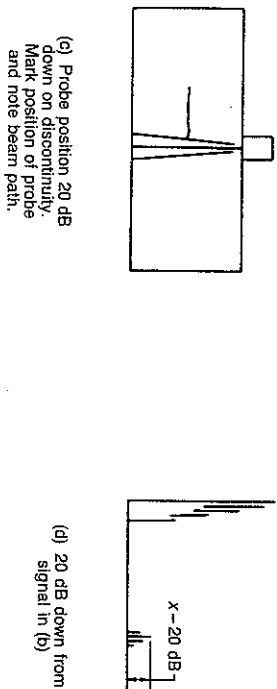
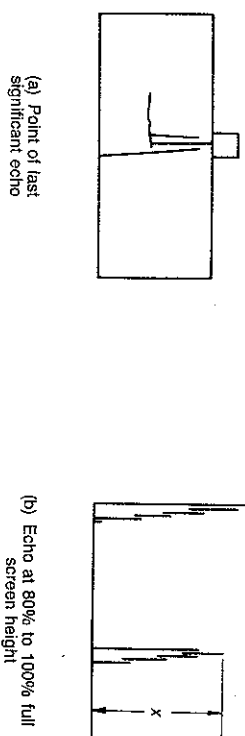

FIGURE G1. PROCEDURE FOR NORMAL PROBES USING 20 DB DROP

COPYRIGHT

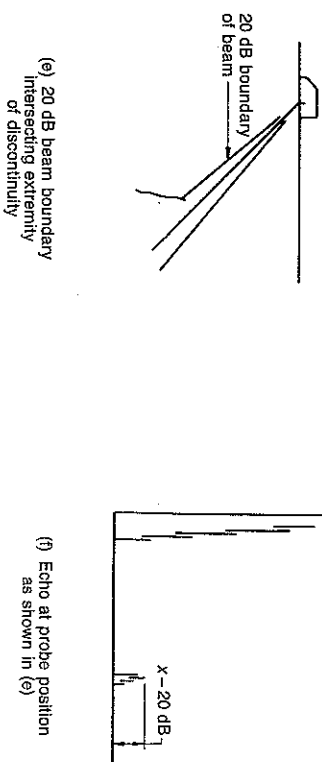
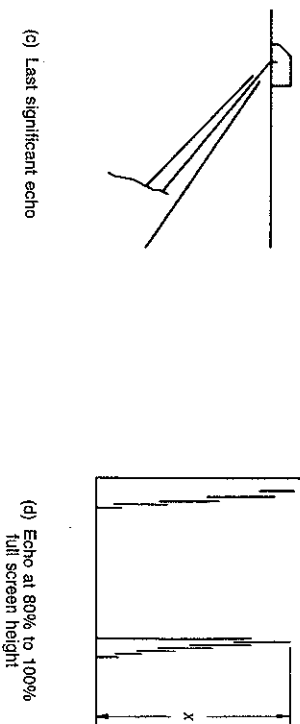
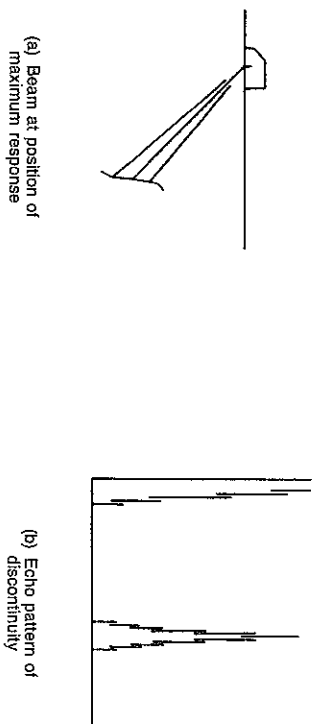
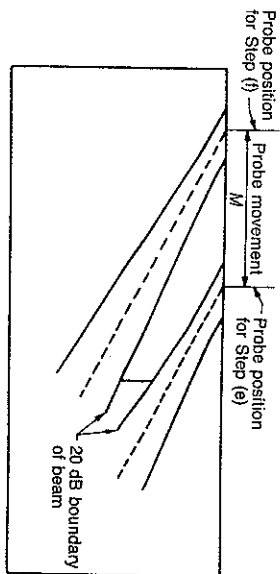

FIGURE G2. PROCEDURE FOR ANGLE PROBES USING 20 DB DROP - VERTICAL PLANE

COPYRIGHT



(g) Determination of vertical dimension

FIGURE G2. (continued)

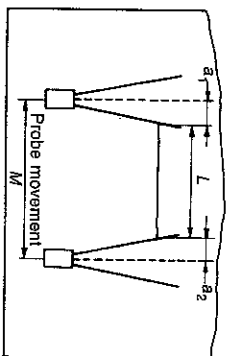

FIGURE G3. PROCEDURE FOR ANGLE PROBES USING 20 DB DROP—  
HORIZONTAL PLANE

COPYRIGHT

## METHODS FOR THE DETERMINATION OF ATTENUATION AND TRANSFER LOSSES

(This Appendix forms an integral part of this Standard)

### APPENDIX H

**H1 SCOPE.** This Appendix sets out methods for determining losses due to attenuation and transfer characteristics using normal and angle probes. Where the difference is greater than 2 dB at the maximum beam path length, the evaluation sensitivity should be adjusted accordingly.

**H2 METHOD FOR NORMAL PROBES** (see Figure H1). The procedure shall be as follows:

- Calibrate the time base using a suitable range.
- Using the metal under test, obtain a number of back echoes at distances  $T_{m1}$ ,  $T_{m2}$ ,  $T_{m3}$ , etc. and plot the amplitude of each echo as shown in Figure H1.
- Using a calibration block, obtain a number of back echoes at distances  $T_{c1}$ ,  $T_{c2}$ ,  $T_{c3}$ , etc. and plot the amplitude of each echo as shown in Figure H1.
- Losses due to attenuation and transfer characteristics are the difference in gain between the two curves, at the appropriate beam path.

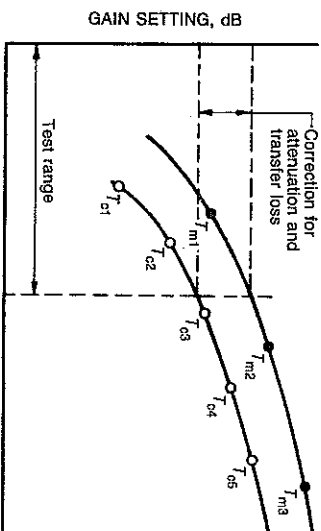

FIGURE H1. TYPICAL PLOT OF GAIN SETTING  
AND BEAM PATH DISTANCE

**H3 METHOD FOR ANGLE PROBES** (see Figure H2). The procedure shall be as follows:

- Calibrate the time base to a suitable range using a single probe having the same characteristics as the test probe.
  - Using two angle probes of the same characteristics as the test probe, one as a transmitter and the other as a receiver, place the probes in positions  $A_1$  and  $A_2$  on the calibration block (see Figure H2(a)) and maximize the amplitude response. Record the instrument gain setting.
  - Repeat Step (b) with probes in positions  $A$  and  $A_3$ , and so on, so as to obtain as many readings as possible.
  - Plot the results as shown by Curve A in Figure H2(c).
  - Using the same angle probes as in Step (b) (one as a transmitter and the other as a receiver), place the probes on the material under test (see Figure H2(b)) and maximize amplitude response. Record the instrument gain setting.
  - Plot the results as shown by Curve B in Figure H2(c).
- NOTE:** If more than one probe position can be achieved it will act as a correction against the first position.
- (B)** The difference in gain between the two curves at the appropriate beam path distance is the attenuation and transfer loss and is added to any gain setting derived from a reflectivity diagram.

COPYRIGHT



**H4 MEASUREMENT OF ATTENUATION COEFFICIENT.** The attenuation coefficient shall be measured at the position showing minimum back echo. When the metal thickness is greater than three probe near zones, the attenuation coefficient ( $AC$ ) shall be calculated from the following equation:

$$AC = \frac{(B_2 - B_1) \text{ dB} - 6 \text{ dB}}{2T}$$

where

$B_1$  = first back echo after three near zones

$B_2$  = first multiple echo after  $B_1$

$T$  = metal thickness, in millimetres.

When metal thickness is less than three near zones, the following equation may be substituted:

$$AC = \frac{(B_2 - B_1) \text{ dB}}{2T}$$

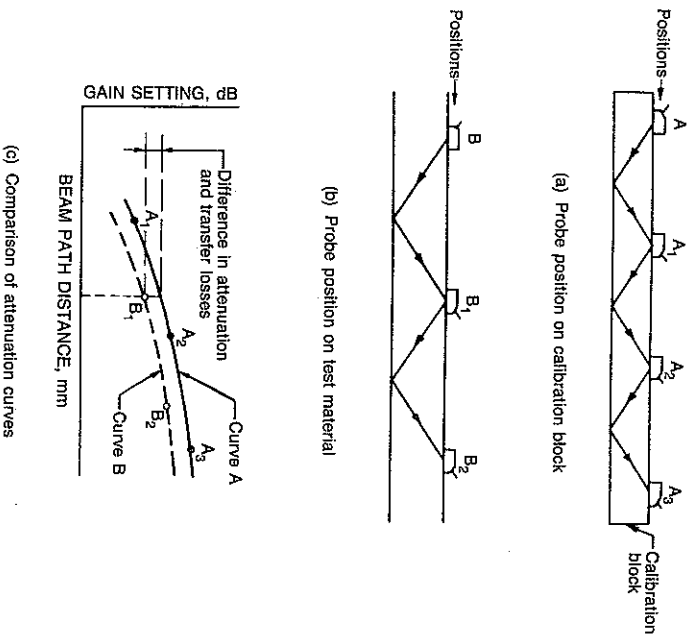

FIGURE H2. METHOD FOR ANGLE PROBES

**PUBLICATIONS OF THE ASSOCIATION**  
A list of Australian Standards may be purchased or inspected at any office of the Association

#### OFFICES OF THE ASSOCIATION

Those interested in the work of the Association are invited to call at the Head Office or any Branch Office, or write for literature.

##### NEW SOUTH WALES:

Head Office: Standards House, 80 Arthur Street, North Sydney 2060.  
Mail: PO Box 458, North Sydney, 2059.  
Telex 26514.

Facsimile (02) 959 3896

Newcastle Branch Office: 51 King Street, Newcastle, 2300.

Facsimile (049) 2 3540

VICTORIA: Clinics Ross House, 191 Royal Parade, Parkville, 3052.

Telex 33877.

Facsimile (03) 347 5914.

QUEENSLAND: 447 Upper Edward Street, Brisbane, 4000.

Mail: PO Box 290, Spring Hill, 4000.

SOUTH AUSTRALIA: 853 Port Road, Woodville, 5011.

Mail: PO Box 416, Woodville, 5011.

Facsimile (08) 347 1033 (Prefix text 'FOR SAA')

WESTERN AUSTRALIA: 11-13 Lucknow Place, West Perth, 6005.

TASMANIA: (Agency: Malcolm, Gray, Morton & Dawson)

97 Murray Street, Hobart 7000.

Facsimile (002) 34 3070

NORTHERN TERRITORY: 191 Stuart Highway, Darwin, 5790.

(Agency: Master Builders Association)

AUSTRALIAN CAPITAL TERRITORY: (Cash sales only) 2A

Mungga Way, Red Hill, 2603. (Agency: Royal Australian Institute of Architects—A.C.T. Chapter.)

Sydney.	(02) 963 4111
Melbourne.	(03) 347 7911
Brisbane.	(07) 831 8605
Adelaide.	(08) 268 6133
Perth.	(09) 321 8797
Hobart.	(002) 34 2211
Newcastle.	(049) 2 2477
Darwin.	(089) 81 9666
Canberra.	(062) 73 2349

NOTE: Copies of international (ISO and IEC) and most foreign Standards can be ordered through the Head Office of the Association. British Standards can also be ordered through all offices except those in the Northern Territory and the Australian Capital Territory.